

Série / Serie / Série / System

N24000



Ref./Code
1638P

Espec. / Caract. / Spec.
PA66

QTY / GR
400 7540

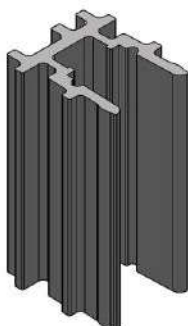
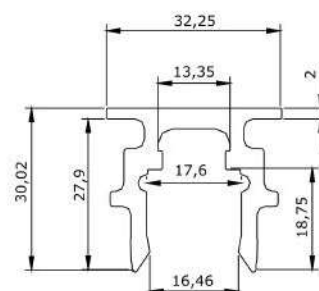

Série / Serie / Série / System

N24000 ESP



Ref./Code
1554P

Espec. / Caract. / Spec.
POM

QTY / GR
200 6630

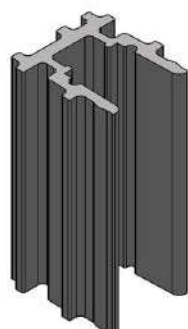
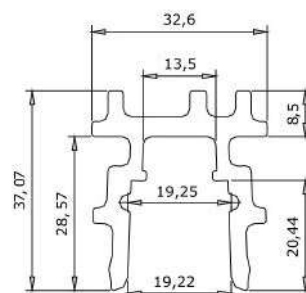

Série / Serie / Série / System

RTC da ealum



Ref./Code
1555P

Espec. / Caract. / Spec.
POM

QTY / GR
200 6150

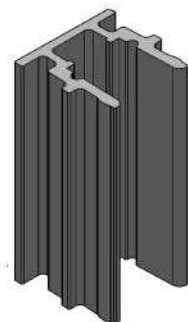
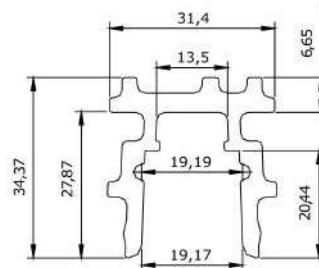

Série / Serie / Série / System

COR 4200 ESP



Ref./Code
F1554P

Espec. / Caract. / Spec.
PA66

QTY / GR
200 5285

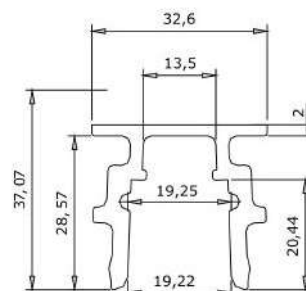

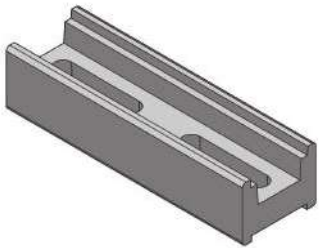

Série / Serie / Série / System

CW



Ref./Code
1682P

Espec. / Caract. / Spec.
PA6

QTY / GR
500 6150

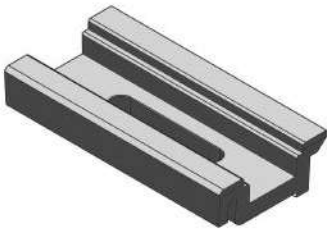
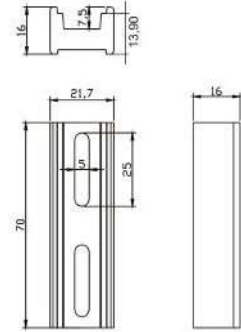

Série / Serie / Série / System

CT



Ref./Code
1721P

Espec. / Caract. / Spec.
PA6

QTY / GR
750 7680

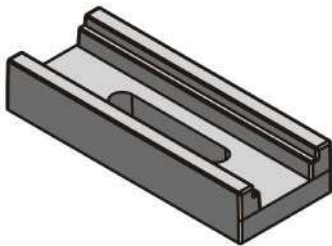
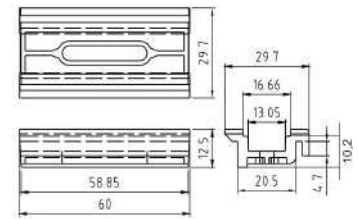

Série / Serie / Série / System

H2 LAAVAL



Ref./Code
1735P

Espec. / Caract. / Spec.
PA6

QTY / GR
750 6610

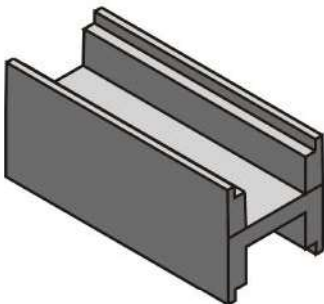
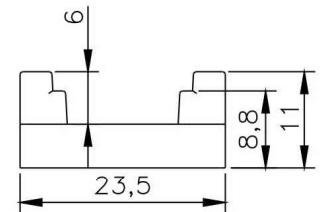

Série / Serie / Série / System

N24200



Ref./Code
1734P

Espec. / Caract. / Spec.
PA6

QTY / GR
500 4500

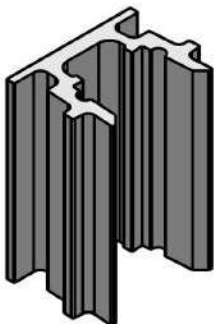
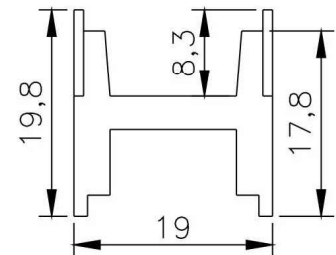

Série / Serie / Série / System

L203000



Ref./Code
1759P

Espec. / Caract. / Spec.
PA66

QTY / GR
400 6600

