



Esquadros Alumínio Aperto Rápido

Ref. **RN 051**

Descrição

Esquadro Alumínio NT48

A - 12; 14; 16; 18

22; 25

B - Centrado;

Descentrado

C - 11 a 14 mm

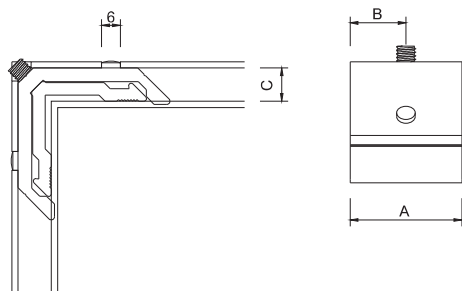

Ref. **RN 052**

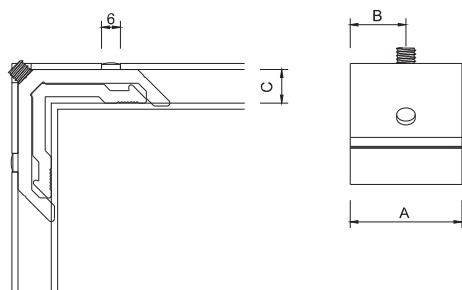

Descrição

Esquadro Alumínio NT48

A - 12; 14; 16; 18

22; 25

B - Centrado;

Descentrado

C - 14 a 18 mm

Ref. **RN 053**

Descrição

Esquadro Alumínio NT48

A - 12; 14; 16; 18

22; 25

B - Centrado;

Descentrado

C - 18 a 23 mm

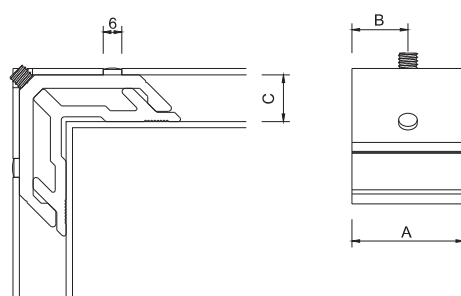

Ref. **RN 054**

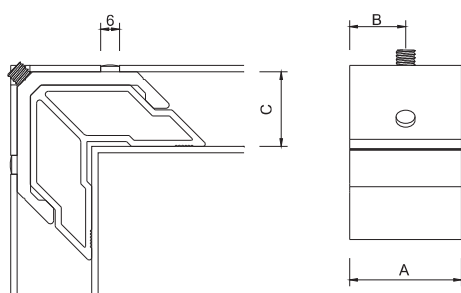

Descrição

Esquadro Alumínio NT48

A - 12; 14; 16; 18

22; 25

B - Centrado;

Descentrado

C - 22 a 25 mm



Ref. RN 055

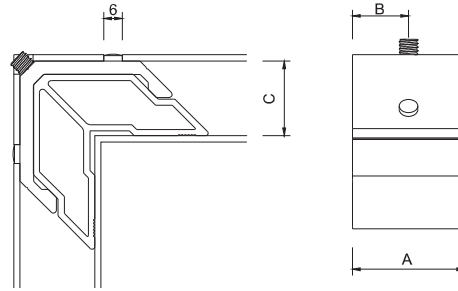

Descrição

Esquadro Alumínio NT48
 A - 12; 14; 16; 18
 22; 25
 B - Centrado;
 Descentrado
 C - 24 a 27 mm

Descrição

Esquadro Alumínio NT48
 A - 12; 14; 16; 18
 22; 25
 B - Centrado;
 Descentrado
 C - 31 a 35 mm

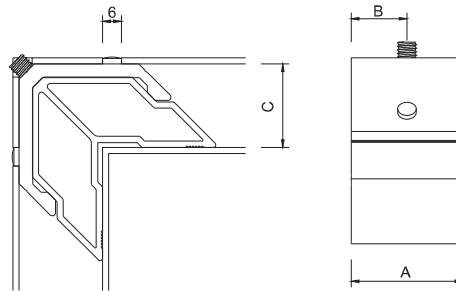

Ref. RN 056



Ref. RN 057

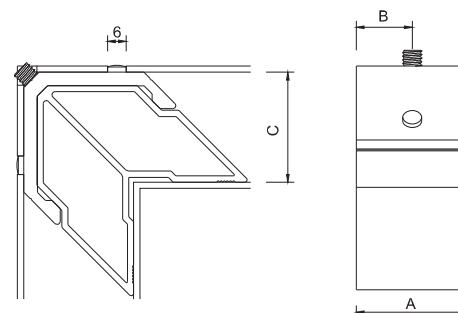

Descrição

Esquadro Alumínio NT48
 A - 12; 14; 16; 18
 22; 25
 B - Centrado;
 Descentrado
 C - 36 a 41 mm