



Esquadros Alumínio Aperto Rápido

Descrição

Esquadro Alumínio NT45

A - 18; 22; 25; 32;
34; 36; 37; 41

B - Centrado;
Descentrado

C - 11 a 14 mm

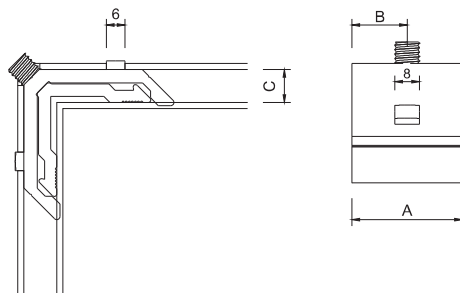

Ref. RN 020



Ref. RN 021

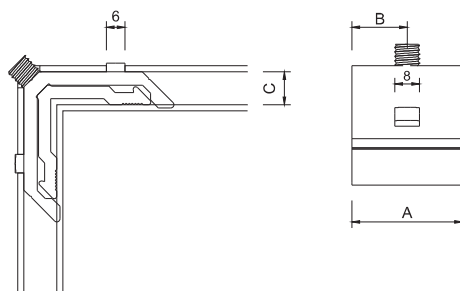

Descrição

Esquadro Alumínio NT45

A - 18; 22; 25; 32;
34; 36; 37; 41

B - Centrado;
Descentrado

C - 14 a 18 mm

Descrição

Esquadro Alumínio NT45

A - 18; 22; 25; 32;
34; 36; 37; 41

B - Centrado;
Descentrado

C - 18 a 23 mm

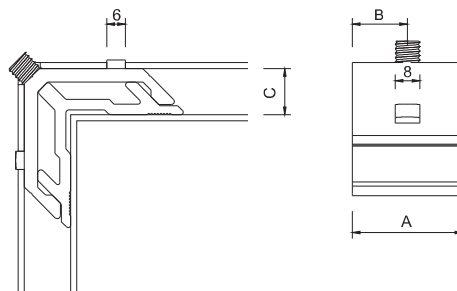

Ref. RN 022



Ref. RN 023

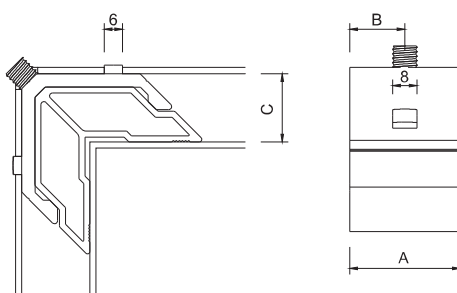

Descrição

Esquadro Alumínio NT45

A - 18; 22; 25; 32;
34; 36; 37; 41

B - Centrado;
Descentrado

C - 22 a 25 mm

Descrição

Esquadro Alumínio NT45

A - 18; 22; 25; 32;
34; 36; 37; 41

B - Centrado;
Descentrado

C - 24 a 27 mm

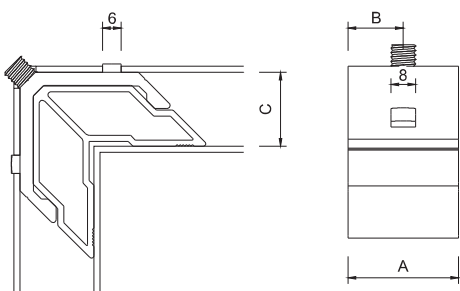

Ref. RN 024





Ref. RN 025

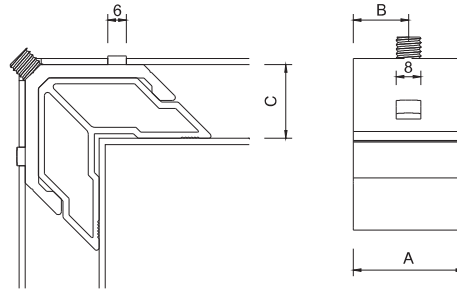

Descrição

Esquadro Alumínio NT45
 A - 18; 22; 25; 32;
 34; 36; 37; 41
 B - Centrado;
 Descentrado
 C - 27 a 31 mm

Descrição

Esquadro Alumínio NT45
 A - 18; 22; 25; 32;
 34; 36; 37; 41
 B - Centrado;
 Descentrado
 C - 31 a 35 mm

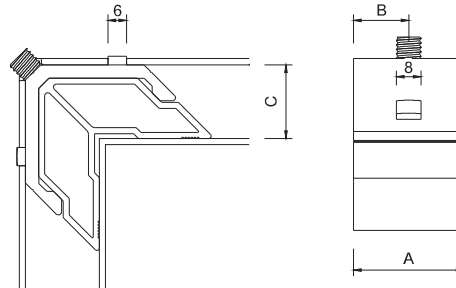

Ref. RN 026



Descrição

Esquadro Alumínio NT45
 A - 18; 22; 25; 32;
 34; 36; 37; 41
 B - Centrado;
 Descentrado
 C - 34 a 39 mm

Ref. RN 027

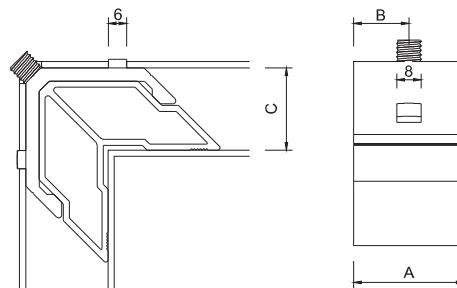

Descrição

Esquadro Alumínio NT45
 A - 18; 22; 25; 32;
 34; 36; 37; 41
 B - Centrado;
 Descentrado
 C - 36 a 41 mm

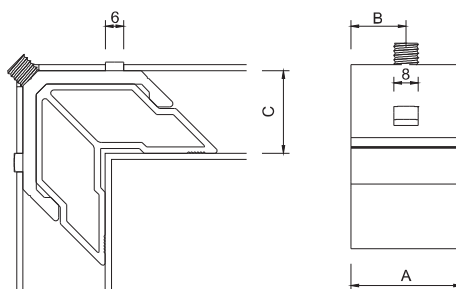

Ref. RN 028



Ref. RN 029

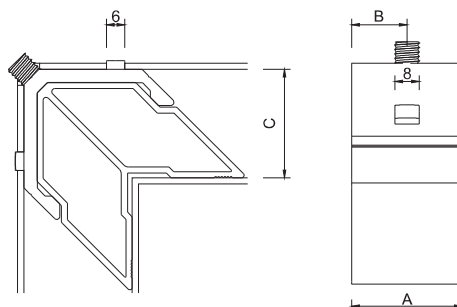

Descrição

Esquadro Alumínio NT45
 A - 18; 22; 25; 32;
 34; 36; 37; 41
 B - Centrado;
 Descentrado
 C - 41 a 46 mm